

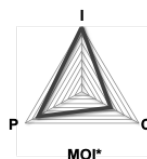

E63 Class, Series X

MPN prefix:

AEX-QCA6391-NI1



A	A	C	4	4	14 weeks
TECHPOINT	LIFESPOT	VAROD	VERTICALS	DCO	ELT

* Page 3 for key legend. Commercial data refresh: June 2020

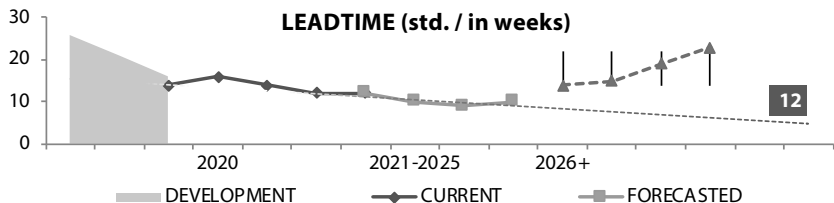

based on Qualcomm QCA6391 - Hastings Reference Design



PRE-APPROVED ANTENNA:

	ANTENNA TYPE	PEAK GAIN	COMPLIANT CUSTOMIZATION
WAPH Series	Internal, PCB Dipole	< 2.5 dBi	Cable length / type / shielding, PCB, labelling, material grade, fine tuning.
WAFH Series	Internal, FPC Dipole	< 3 dBi	Cable length / type / shielding, FPC, labelling, material grade, fine tuning.
WAMF Series	Internal, F-Type PIFA	< 3 dBi	Cable length / type / shielding, PIFA design, labelling, material grade, fine tuning.
WACI Series	Internal, SMT Chip	< 3 dBi	Chip design, identification, material grade, fine tuning.
WAND & WEAD Series	External, PCB Dipole	< 5 dBi	Cable length / type / shielding, PCB, enclosure, identification, material grade, fine tuning.

When indicated: * certified On-Demand † list may vary by domain

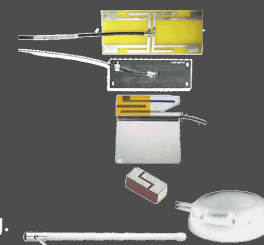



Revision History

RELEASES	DATE	NOTES	PREPARED	APPROVED
Version 1.0	2020-02-28	EVT based	A Chen	LTu
Version 1.1	2020-03-27	Cover page and label: visual corrections. Updated ordering information table.	W.O.	LTu
Version 1.2	2020-05-29	Block diagram clarification & enhanced power consumption specifications.	W.O.	LTu
Version 1.3	2020-12-15	Amended z-height information	W.O.	LTu

* Commercial Key Legend

Indicators that assess the specific product for its position in the technology curve and the supply chain responsiveness it enjoys. They combine an inner-outer view: both from outside factors and from internal corporate and production support.

MOI [Market Orientation Index] A value calculated from the grading of the factors below. Used as a rule-of-thumb to aid design-in and procurement evaluation. MOI depicts the present product affinity to Innovation (I), Customer Empathy (C) and Price Focus (P).

TECHNOLOGY High to Low: Advanced (A), Barring (B), Common (C), Dissolving (D)

AGE Life cycle spot. Early to Late: Agonist (A), Bold (B), Current (C), Distressed (D)

VAROD [Variants On-Demand] Flexibility in creating variants (Rigid to Flexible): Auxiliary (A), Basic (B), Core (C), Deep (D).

VERTICALS Applicability in vertical markets: Specialized to a single market (1), to application in multiple verticals (4).

DCO [Design Cost Orientation] Commodity index related to the cost point for the product’s design conception. VALUES: 1 to 4; the higher the number the more cost aware is the core design.

ELT [Effective Lead Time] Adjusted lead-time in weeks. This is a compound value based on the timeframe for the fulfillment of the 90% of unscheduled orders received accounting also for the industrial lead-time and internal inventory buffering. VALUE: number of ELT weeks.



E63 CLASS, SERIES X 1

AEX-QCA6391-N11 ERROR! BOOKMARK NOT DEFINED.

INDUSTRIAL GRADE 1775 MBPS MODULE, WITH DUAL-BAND SIMULTANEOUS 802.11AX AC/ABGN WLAN VIA PCIE AND BLUETOOTH 5.2 VIA HCI UART PLUS PCM FOR LE AUDIO – FULLSIZE MINIPCI EXPRESS MODULE..... 1

REVISION HISTORY 2

*** COMMERCIAL KEY LEGEND..... 2**

1. DESCRIPTION..... 4

2. TOP FEATURES..... 4

3. SPECIFICATIONS..... 5

4. ELECTRICAL CHARACTERISTICS..... 8

4.1 ABSOLUTE MAXIMUM RATINGS 8

4.2 GPIO INTERFACE CHARACTERISTICS 8

5. MECHANICAL DRAWING 9

6. CONNECTOR PIN-OUT DEFINITIONS..... 10

7. BLOCK DIAGRAM 11

8. ENVIRONMENTAL PERFORMANCE QUALIFICATION 11

9. STANDARD DOMAIN CODE & IDENTIFICATION..... 12

10. PRODUCT LABEL 12

10.1 FRONT (SHIELD) REGULATORY LABEL 12

10.2 ON-DEMAND LABELLING..... 12

11. ESD PROCESSES 12

12. PACKAGING, STORAGE AND HANDLING..... 13

13. ORDERING INFORMATION..... 14

14. NOTICES 15

VOXMICRO PROFILE 16



1. Description

Dual Band Simultaneous 2x2 Wi-Fi 6 MiniPCI Express: mPCIe modules that offer a full implementation of the Wi-Fi 6 standard (IEEE 802.11ax). The same wireless processor that is part of the FastConnect 6800 and Networking Pro architectures, the QCA6391 Chipset, is he providing the engineering power of this world leading IC Vendor in a compact solder-down module format.

The E63 Class operates a dual MAC for connections up to 1774.5Mbps data rate (2x2+2x2 11ax DBS). The use of OFDMA and MU-MIMO protocols, both in full UL and DL, effectively doubles the throughput performance and delivers up to 50 percent additional range compared to Wi-Fi 5 devices; even in dense networking environments and with multiple concurrent MU-MIMO links running via a single module.

All the advanced features: empower system design with all the actual advanced features of power-management, Target Wakeup Time (TWT), Multi-BSSID and Multi-TID, Spatial Reuse, 8 Stream Sounding, WPA3 including all optional and additional elements of it, seamless antenna sharing with LTE, LTE-U and 5G, offloading traffic for minimal host utilization also at 11ac/ax speeds, low power PCIe (w/L1 sub-state) interface, integrated close-loop power detector and more. All the wireless modes are supported, also at mixed concurrency (i.e. STA+SAP).

Separate Bluetooth 5.2 on-board: full clock-cycle BT management on an independent antenna chain with all the latest features of BT5.2 and more, like: BLE long range, Enhanced Attributes, LE Audio & Power, Isochronous Channels, dual eSCO and dual A2DP stream-split, ACL support for A2DP true stereo, aptX Adaptive R2 over TWS+, Super Wideband (SWB) Codec, SWB over TWS+, QHS (QC Advanced Channel Coding).

CoB+adaptation, antenna and grade: other than in full mini-PCIe form-factor, the E63B ([Series B](#)) CoB core is available for direct SMT, and on carriers to M.2 E-Key ([Series W](#)) & B-Key ([Series F](#)). Integration options include choice of antenna connector and operating temperature.

2. Top Features



- True Industrial Grade (-40 ~ +85°C), fully feature Wi-Fi 6 CoB-based module with flexible antenna configurations
- Dual Band Simultaneous (DBS) with dual MAC, 2.4Ghz + 5 Ghz wireless connection up to 1775Mbps that supports DL and UL MU-MIMO
- Separate antenna for fully independent Bluetooth 5.2 on-board, with Enhanced Attributes, LE Audio & Power and Isochronous Channels
- Full external FEM design with enhanced range, energy and Tx power accuracy; 24dBm aggregate output for WLAN and 19dBm for BT



3. Specifications

SOLUTION DESIGN	Chipset	Qualcomm QCA6391
	Standard	IEEE 802.11ax Wi-Fi 6 plus Bluetooth 5.2 Combo, full backwards compatibility to previous standards
	Industrial Reference	Based on Qualcomm Atheros Hastings reference design
APPEARANCE	Communications Interface	Mini-PCI Express edge connector: WLAN: via PCI Express Standard 2.1 host I/O BT: via HCI UART and I2S (Virtual-USB mapping at SW level); PCM and I2C are available
	Form Factor	Slotted, Socketed, Mini PCIE format, standard mPCIe dimensions – Full size card [CoB soldered on carrier]
ANTENNA	Configuration	WLAN: Two Streams (2 chains), 2x2, 2 Connectors, MU-MIMO BT: One Stream (1 chain), 1x1, 1 Connector
	Type	Three on-board U.FI. connector receptables
WIRELESS PARAMETERS	Frequency Band	WLAN: 2.4 GHz ISM Bands 2.412-2.472 GHz, 2.484 GHz 5.15-5.25 GHz (FCC UNII-low band) for US/Canada, Japan and Europe 5.25-5.35 GHz (FCC UNII-middle band) for US/Canada and Europe 5.47-5.725 GHz for Europe 5.725-5.825 GHz (FCC UNII-high band) for US/Canada
		BT: 2402MHz~2480MHz
	Data Transfer Rates	WLAN: 802.11ax: Up to 1774.5Mbps (dynamic) 802.11ac: Up to 867Mbps (dynamic) 802.11n: Up to 300Mbps (dynamic) 802.11a/g: Up to 54Mbps (dynamic) 802.11b: Up to 11Mbps (dynamic)
		BT: GFSK at 1Mbps $\pi/4$ -DQPSK at 2Mbps 8DPSK at 3Mbps
	Media Access Control	CSMA/CA with ACK
	Channel	2.4GHz: 1-13 (14 only for Japan) 5GHz: 36-64, 100-165
	Channel Spacing	5MHz, 10MHz, 20 MHz, 40Mhz selectable for 2.4Ghz band. 80Mhz is also available for the 5Ghz band.
	Spreading / Modulation	WLAN: 802.11ax: OFDMA (BPSK, adds 1024-QAM on MCS10 and MCS11) 802.11ac/g/n: OFDM (BPSK, DSSS-OFDM, QPSK, 16-QAM, 64-QAM, 256-QAM), MRC, STBC, LDPC, ML Demodulation 802.11b: CCK (11, 5.5Mbps), DQPSK (2Mbps), BPSK (1Mbps)
		BT: GFSK, $\pi/4$ -DQPSK, 8DPSK



WIRELESS PARAMETERS	RF Output Power	802.11b:	22.5 dBm at 11M	±2 dBm	
		802.11g:	20 dBm at 54M	±2 dBm	
		802.11a:	18.5 dBm at 54M	±2 dBm	
		802.11n/ax 2.4G V/HT20	20.5 dBm at MCS0	19 dBm at MCS7	±2dBm
		802.11n/ax 2.4G V/HT40	19 dBm at MCS0	17.5 dBm at MCS7	±2dBm
		802.11ax 2.4G VHT40	17.5 dBm at MCS0	15 dBm at MCS7	±2dBm
		802.11n/ac/ax 5G V/HT20	20.5 dBm at MCS0	19.5 dBm at MCS7	±2dBm
		802.11n/ac/ax 5G V/HT40	19.5 dBm at MCS0	17.5 dBm at MCS7	±2dBm
		802.11ac/ax 5G VHT80	17.5 dBm at MCS0	16.5 dBm at MCS9	±2dBm
		802.11ax 5G VHT80	16.5 dBm at MCS0	15 dBm at MCS11	±2dBm
		<ul style="list-style-type: none"> • DBm values reflect single RF chain output power performance. Two chain combined output power can be calculated as the single chain output power plus 3dB (2Tx = 1Tx + 3dB). 			
		BT: (Class 2 Mode) +2 dBm ≤ Output Power ≤ +6 dBm (Class 1 Mode) +2 dBm ≤ Output Power ≤ +20 dBm			
WIRELESS PARAMETERS	RF Receive Sensitivity (Typical, 1x1 chain)	802.11b	11M less than 91 dBm		
		802.11g	54M less than 77 dBm		
		802.11a	54M less than 77 dBm		
		802.11n/ax 2.4G V/HT20	MCS7 less than 77 dBm		95 dBm at MCS0
		802.11n/ax 2.4G V/HT40	MCS7 less than 73.5 dBm		92.5 dBm at MCS0
		802.11ax 2.4G VHT20	MCS9 less than 71.5 dBm, MCS11 less than 64 dBm		94.5 dBm at MCS0
		802.11ax 2.4G VHT40	MCS9 less than 68 dBm, MCS11 less than 62 dBm		92 dBm at MCS0
		802.11n/ac/ax 5G V/HT20	MCS7 less than 77 dBm		95 dBm at MCS0
		802.11n/ac/ax 5G V/HT40	MCS7 less than 74.5 dBm		92.5 dBm at MCS0
		802.11ax 5G V/HT20	MCS9 less than 70 dBm, MCS11 less than 64 dBm		85 dBm at MCS0
				85 dBm at MCS0	
				85 dBm at MCS0	
		BT: BER < 0.1% (Anritsu 8852B Tx -83Bm)			
	Operating Range	Open Space: ~300 m; Indoor: ~100 m (Coverage vary according to environment, antenna and topography)			
	Wireless Security	WEP 64-bit and 128-bit encryption WPA/WPA2/WPA3 UL/DL (Wi-Fi Protected Access)			
MODALITIES	Infrastructure, AP/STA, Client, Bridge, Mixed-mode, P2P/Ad-hoc				
SAFETY & REGULATORY	Compliant with FCC, CE RED, ISED, Japan TELEC and more. Compliant with RoHS3.				
PROTOCOLS	IEEE WLAN Network	802.11ax, 802.11ac, 802.11n, 802.11g, 802.11b, 802.11a, 802.11d, 802.11e, 802.11h, 802.11i, 802.11k, 802.11r, 802.11u, 802.11v and 802.11w.			
	Other Standards				
	Industry Standards				



HOST SYSTEM REQUIREMENTS	Operating System	Android/Linux Closed Source, Android/Linux Open Source, Qualcomm Embedded Platform, Windows, MacOS						
	Operating Temperature	-40 ~ +85° Celsius						
ENVIRONMENT	Storage Temperature	-50° ~ +135° Celsius						
	Operating Humidity	10%~90% non-condensing						
	Storage Humidity	5%~90% non-condensing						
ELECTRICAL	I/O Voltage	3.3V +/-5%						
	Power Consumption	PROTOCOL	RATE	VOLTAGE	2x2 CTx	2x2 CRx	1x1 CTx	1x1 CRx
		802.11b	at 1Mbps	3.3V	667.0 mA	77.5 mA	372.4 mA	60.5 mA
		802.11g	at 6Mbps	3.3V	610.0 mA	88.5 mA	340.3 mA	71.4 mA
		802.11a	at 6Mbps	3.3V	665.1 mA	94.2 mA	385.5 mA	73.9 mA
		802.11n on 2GHz	at HT20, MCS0	3.3V	597.4 mA	87.2 mA	327.1 mA	70.1 mA
		802.11n on 5GHz	at HT20, MCS0	3.3V	639.6 mA	119.8 mA	369.8 mA	98.1 mA
		802.11ac on 2GHz	at VHT20, MCS7	3.3V	483.0 mA	87.4 mA	274.8 mA	70.4 mA
		802.11ac on 5GHz	at VHT40, MCS9	3.3V	611.3 mA	146.1 mA	358.9 mA	118.7 mA
		802.11ax on 2GHz	at HE40, MCS11	3.3V	460.5 mA	97.1 mA	286.8 mA	74.6 mA
		802.11ax on 5GHz	at HE80, MCS11	3.3V	553.0 mA	164.7 mA	333.1 mA	133.0 mA
	<ul style="list-style-type: none"> • Electronic current values in milliampere. Readings retrieved under stable, typical current and voltage. • Power consumption ratings are statistical maximums in test system setups which are placed in continuous operating modes. • Real-life application system power budgets are dependent on traffic mix, environment, topology and domain configuration. 							
MECHANICAL	Dimensions	50.95mm x 30mm x 3.50mm (with shielding @ ±0.12mm accuracy). * The back side of the module features few capacitors that add up to 0.9mm at those specific points.						
	Weight	6.5 g						
PACKAGING	Packing style	ESD Sleeves in Carton Bulk Package (Optional Tray or Reel Packaging)						
	Package Contents	Module only						



4. Electrical Characteristics

4.1 Absolute Maximum Ratings

SYMBOL	PARAMETER	MAX. RATING	UNIT
Vdd33	Maximum range of I/O supply voltage	3.135~3.465	V
RFin	Maximum RF input (reference to 50 Ω)	+10	dBm
Tstore	Storage temperature	-50~135	°C

4.2 GPIO Interface Characteristics

See related detailed Pin Mapping and Application Notes documents.



5. Mechanical Drawing

Mechanical drawing in millimetres (mm) and in thousandths of an inch (mil), showing the module's component and shield side (top view):

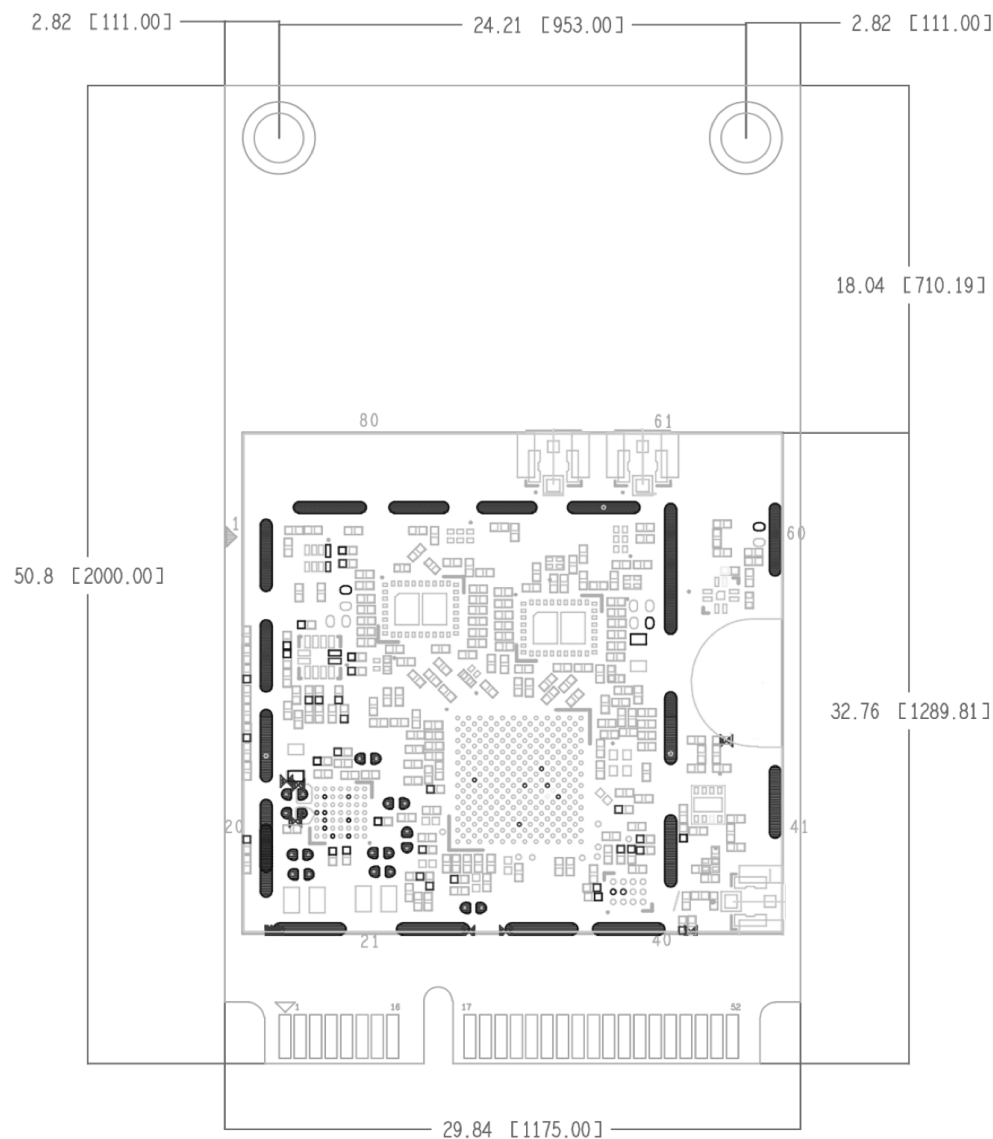



6. Connector Pin-out definitions

PIN NO.	DEFINITION
PIN 2	3.3V
PIN 8	UART_Wake_Host
PIN 10	BT_UART_TXD
PIN 12	BT_UART_RXD
PIN 14	BT_UART_RTS
PIN 16	BT_UART_CTS
PIN 20	W_DISABLE1_L
PIN 22	PE_RST0_L
PIN 24	3.3V aux
PIN 30	DBG_UART_RXD
PIN 32	DBG_UART_TXD
PIN 44	WL_LED_3P3
PIN 46	LED2
PIN 52	3.3V aux

PIN NO.	DEFINITION
PIN 1	PE_WAKE0_L
PIN 3	LTE_COEX_RXD
PIN 5	LTE_COEX_TXD
PIN 7	CLKREQ0_L
PIN 11	HST_PCIE_REFCLKN
PIN 13	HST_PCIE_REFCLKP
PIN 17	W_DISABLE2_L
PIN 19	Wake_BT
PIN 23	HST_PCIE_TXP
PIN 25	HST_PCIE_TXN
PIN 31	HST_PCIE_RXP
PIN 33	HST_PCIE_RXN
PIN 39	3.3V aux
PIN 41	3.3V aux
PIN 45	BT_PCM_CLK
PIN 47	BT_PCM_SYNC
PIN 49	BT_PCM_OUT
PIN 51	BT_PCM_IN

PIN NO.	DEFINITION
4	GND
9	GND
15	GND
18	GND
21	GND
26	GND
27	GND
29	GND
34	GND
35	GND
37	GND
40	GND
43	GND
50	GND

INTERFACE TYPE	BUS SIGNALING	STANDARD
Mini-PCI Express Connector	PCIe	PCIe 2.1
	HCI UART	3.2Mbps
	PCM/I2S/I2C	

*Physical Layer Form Factor follows standard PCIe definitions. Depiction, with pin guidance of the edg connector pads, below:

MODULE'S BOTTOM SIDE

MODULE'S TOP (EMI SHIELD) SIDE

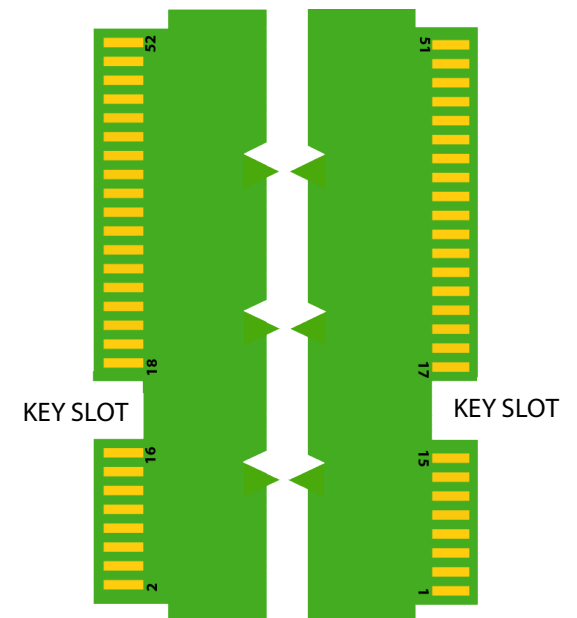

*Pin/Contact Numbers not appearing in the above table are either reserved or unused.



7. Block Diagram

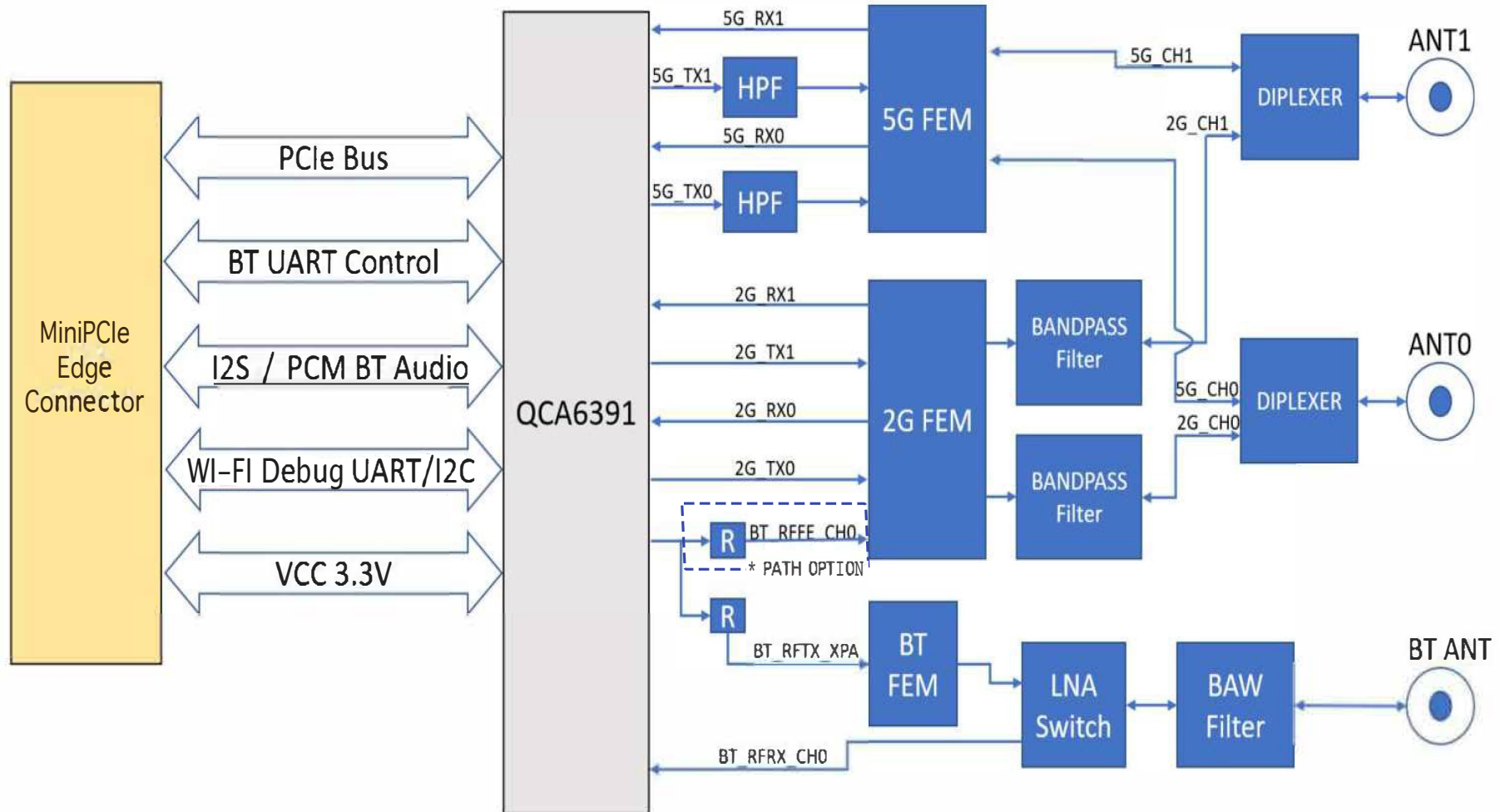

* On-Demand BT Combo on ANT0 instead of the separate chain & antenna.

8. Environmental Performance Qualification

At the time of writing this document, throughput test at controlled thermal conditions are to be scheduled. Any related enquiries can be addressed to your sales / account manager.



9. Standard Domain Code & Identification

The Regulatory Domain pre-programmed as standard is 0x6A [wide open world mode]. Other regulatory domain codes can be pre-programmed on-request at production level. Standard identifiers are based on the Qualcomm reference design:

	VENDOR ID (VID)	SUBSYSTEM VENDOR ID (SVID)	DEVICE ID (DID)	SUBSYSTEM ID (SSID)
STANDARD WLAN	0x17CB	0x17CB	1x01	0x40

10. Product Label

10.1 Front (Shield) Regulatory Label

Standard label is shown here with applicable marking, including some regulatory domain identifiers:

- FCC (USA), ISED (Canada), CE RED (Europe), Japan and EU Safety & Environmental.
- Wireless LAN NIC MAC ID label (human legible and barcode).
- Serial Number label (human legible and barcode) plus Variant Number



10.2 On-Demand Labelling

Labels and product support materials can be flexibly tailored to OEM/ODM customer’s requirements to support practices, target domains and specific markets.

11. ESD Processes

The AEX-QCA6391 constitutes a sensitive electronic device and caution is required when handling it. ESD handling, shipment and storage notices apply. Also see the general Notices Section included in this document.



**DO NOT OPEN OR HANDLE
EXCEPT AT A STATIC-FREE
WORKSTATION**

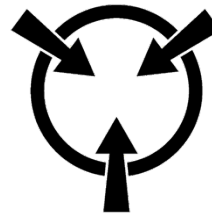

**DO NOT SHIP OR STORE NEAR STRONG
ELECTROSTATIC, ELECTROMAGNETIC OR
RADIOACTIVE FIELDS**

12. Packaging, Storage and Handling

ESD Sleeve, Inner Box & Outer Carton level standard packing schematic for retail samples*, follows. Packaging in matrix tray is TBC.

* Packaging modality and artwork can flexibly follow OEM/ODM customer requirements.
** The Packaging modality and the selection of its materials is made with environmental responsibility and commitment to resource preservation. Please reuse and recycle where possible.



	MODULE IN ESD SLEEVE	INNER BOX KIT (K)	MASTER CARTON (M)
CONTENT (UNITS)	1	60	960
INVENTORY SKU	AEX-QCA6391-NI1	AEX-QCA6391-NI1-K	AEX-QCA6391-NI1-M
UPC	812069021656	812069021663	812069021670
OUTER DIMENSIONS	70 x 60 x 3.5 mm	204 x 165 x 65 mm	430 x 350 x 285 mm
GROSS WEIGHT	6.5 gr	410 gr	6.500 gr
PICK & PACK METHOD	Padded envelope or carton box depending on quantity. Padded & separated.	In outer carton packaging.	As-is.
PACKAGING COMPLIANCE **	ANSI/ESD S20.20, IEC 61340-5-1, RoHS3	RoHS3	RoHS3
MOISTURE SENSITIVITY LEVEL (MSL)	IPC/JEDEC J-STD-020: MSL2	IPC/JEDEC J-STD-020: MSL1	IPC/JEDEC J-STD-020: MSL1
HTS CODE (HS)	8517.62	8517.62	8517.62
COUNTRY OF ORIGIN (COO)	158 - Taiwan	158 - Taiwan	158 - Taiwan
NAFTA / ECCN	On request	On request	On request



13. Ordering Information

E63X Series public variant products and related ordering information:

	ORDERING P/N	VARIANT ID	DESCRIPTION	
STANDARD PRODUCT, U.FL CONNECTORS, RETAIL PACK	AEX-QCA6391-NX1	-/A/01	- Standard product - Standard sampling packaging - U.FL / IPEX connectors on-board	
INDUSTRIAL PRODUCT, U.FL CONNECTORS, RETAIL PACK	AEX-QCA6391-NI1	-/B/02	- Standard product - Standard sampling packaging - U.FL / IPEX connectors on-board - Industrial operating temperature	THIS PRODUCT
STANDARD PRODUCT, MHF4 CONNECTORS, RETAIL PACK	AEX-QCA6391-NX4	-/C/03	- Standard product - Standard sampling packaging - MHF4 connectors on-board	
INDUSTRIAL PRODUCT, MHF4 CONNECTORS, RETAIL PACK	AEX-QCA6391-NI4	-/D/04	- Standard product - Standard sampling packaging - MHF4 connectors on-board - Industrial operating temperature	

Same CoB design ([Series B](#)) on alternative carrier form-factors are available: M.2 E-Key ([Series W](#)) and M.2 B-Key ([Series F](#)).



14. Notices

STORAGE: The product shall be stored, and the package shall remain closed according to storage environmental conditions noted within this datasheet. - The product shall be stored in non-corrosive gas (Cl₂, NH₃, SO₂, Nox, etc.). - No excess mechanical shock shall be applied including, but not limited to, sticking the packing materials by sharp object and dropping the product, in order to avoid damaging the packing materials.

SHELF LIFE: Products left more than two years after reception need to have their specifications confirmed prior to use.

HANDLING: Care in handling or transporting products is required as excessive stress or mechanical shock may break products. - Cracks or damages on products' terminals may lead to changes in their characteristics. Products are not to be touched with bare hands as this may result in electrostatic damage. - Application of static electricity or overvoltage may cause defect in the product or deterioration of its reliability, and caution must be taken against exposure to any static electricity generated by electrified items such as workbenches, soldering irons, tools, carrying containers, etc.

LAND PATTERN & DIMENSIONS: All ground terminals should be connected to the ground patterns. Furthermore, the ground pattern should be provided between IN and OUT terminals. Please refer to the specifications for standard land dimensions.

MECHANICAL PLACEMENT: When mounting products connected to other components, products may be stressed and broken by uneven forces. To prevent such damages, compliance with specifications for the tools and interfaces being used is required.

CLEANING: As this Product is Moisture Sensitive, no cleaning is permitted.

OPERATIONAL ENVIRONMENTAL CONDITIONS: Products are designed to work as part of electronic compositions under normal environmental conditions (ambient temperature, humidity and pressure). Operation under the following circumstances may damage the products and leakage of electricity and abnormal temperature may occur:

In an atmosphere containing corrosive gasses (Cl₂, NH₃, SO_x, NO_x) or combustible / volatile gases - Dusty places - Places of direct sunlight - Water splashing zones - Humid places where water condenses - Freezing places

In the instance of potential operation in such environments, consult with AIRETOS before actual use. Application of static electricity or excessive voltage while assembling and measuring is discouraged as it might be a cause of degradation or destruction.

INPUT POWER CAPACITY: Products shall be used in the input power capacity specified in this datasheet. If components are to be used beyond the documented input power capacity range, prior consultation with VOXMICRO is advised.

LIMITATION OF APPLICATIONS: The product is designed and manufactured for consumer application only and is not available for any application listed below which requires significantly high reliability for the prevention of defects that may directly cause damage to the third party's life, body or property.

- Aircraft equipment - Aerospace equipment - Undersea equipment - Power plant control equipment - Medical equipment - Transportation equipment (vehicles, trains, ships, etc.) - Traffic signal equipment - Disaster prevention / crime prevention equipment - Data-processing equipment - Application of similar complexity and/ or reliability requirements to the applications listed in the above.

If the product is to be used in equipment or electric circuit that requires high safety or reliability function / performances, sufficient reliability evaluation check for safety shall be performed prior to commercial shipment and consideration for the installation of a protective circuit at customer's design stage is strongly recommended. Please provide and appropriate fail-safe function on the customer's product to prevent any damages that may be caused by the abnormal function or the failure of our product.

QUALITY CONTROL: Testing and quality control is applied to the extent VOXMICRO deems necessary. Unless mandated by government requirements, VOXMICRO does not necessarily test all parameters of each product.

LIFECYCLE: Please note that VOXMICRO may discontinue the manufacture of products, due to reasons such as end of supply of materials and/or components from our suppliers.

CONFORMITY: Please make sure that your product has been evaluated and confirmed against your specifications when the AIRETOS product is mounted to your product. Please conduct validation and verification of the products in actual condition of mounting and operating environment before commercial shipment of the equipment. All the items and parameters in this product specification have been prescribed on the premise that our product is used for the purpose, under the condition and in the environment agreed upon between you and us. You are requested not to use our product deviating from such agreement. We consider it not appropriate to include other terms and conditions for transaction warranty in product specifications, drawings or other technical documents. Therefore, even if your original part of this product specification includes such terms and conditions as warranty clause, product liability clause, or intellectual property infringement liability clause, we are not able to accept such terms and conditions in this product specification unless they are based on the governmental regulation or what we have agreed otherwise in a separate contact. We would like to suggest that you propose to discuss them under negotiation of contract.

DISCLAIMER: Please note that the only warranty that provides regarding the products is its conformance to the specifications provided herein. Accordingly, VOXMICRO shall not be responsible for any defects in products or equipment incorporating such products, which are caused under the conditions other than those specified in this specification.

VOXMICRO HEREBY DISCLAIMS ALL OTHER WARRANTIES REGARDING THE PRODUCTS, EXPRESS OR IMPLIED, INCLUDING WITHOUT LIMITATION ANY WARRANTY OF FITNESS FOR A PARTICULAR PURPOSE, THAT THEY ARE DEFECT-FREE, OR AGAINST INFRINGEMENT OF INTELLECTUAL PROPERTY RIGHTS. YOU AGREE TO INDEMNIFY AND DEFEND VOXMICRO AND ITS AFFILIATES AGAINST ALL CLAIMS, DAMAGES, COSTS, AND EXPENSES THAT MAY BE INCURRED, INCLUDING WITHOUT LIMITATION, ATTORNEY FEES AND COSTS, DUE TO THE USE OF PRODUCTS.

VOXMICRO's liability under this warranty shall be limited to products that are returned during the warranty period to the address designated by VOXMICRO and that are determined by VOXMICRO not to conform to such warranty. If VOXMICRO elects to repair or replace such products, AIRETOS shall have reasonable time to repair such products or provide replacements. Repaired products shall be warranted for the remainder of the original warranty period. Replaced products shall be warranted for a new full warranty period.

For avoidance of doubt, VOXMICRO shall not be liable for any defects that are caused by neglect, misuse or mistreatment by an entity other than VOXMICRO including improper installation or testing, or for any products that have been altered or modified in any way by an entity other than VOXMICRO. Moreover, VOXMICRO shall not be liable for any defects that result from your or third party's design, specifications or instructions for such products.



VOXMICRO PROFILE

Distributed Locations & Customer-Centric Operations



Quality processes at all stages



OF REVENUE

• INVESTED IN INNOVATION R&D



HANDS-ON IN

• OEM/ODM WIRELESS MODULE MARKET



DECADES OF

• CUMMILATIVE ENGINEERING EXPERIENCE



HUNDREDS OF

• ROUTINE INDUSTRIAL CUSTOMERS



THOUSANDS OF

• TUNING HOURS YEARLY



MILLIONS OF

• INTERNAL AND EXTERNAL INVESTMENTS