

- SOURCING ADVISORY
- PROACTIVE SUPPLY CHAIN
- ON-DEMAND CO-SPONSORING
- GUARANTEED QUALITY OEM

MPN

# AEX-QCA9890-NI

UPC

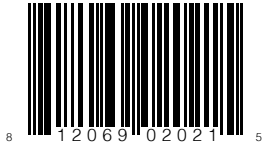

CLICK OR SCAN



@ AIRETOS.com

PRODUCT PAGE

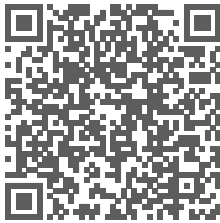

Request Now

EVALUATION / RFQ



@ OxfordTEC

SAMPLES

## Military Grade 1.3Gbps Three Chain, Dual Band 802.11ac/abgn WLAN – Industrial Temperature Grade, Full Size MiniPCI Express Module

Based on QUALCOMM ATHEROS Reference Design XB140 (Peregrine)

### DATASHEET

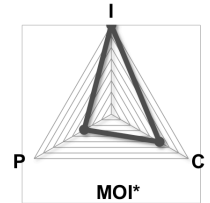

A	A	B	2	1	16 weeks
TECHPOINT	LIFESPOT	VAROD	VERTICALS	DCO	ELT

\* Page 2 for key legend. Commercial data refresh: June 2015

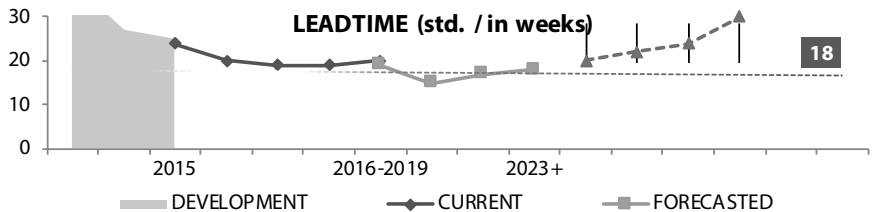

FOR FURTHER INFORMATION, DEVELOPMENT SAMPLES, CUSTOMIZATION AND VOLUME PRICING CONTACT US VIA AIRETOS.COM OR VIA THE VOXMICRO GROUP WHOLESALERS - FOR CONTACTS SEE [WWW.VOXMICRO.TEL](http://WWW.VOXMICRO.TEL)



- SOURCING ADVISORY
- PROACTIVE SUPPLY CHAIN
- ON-DEMAND CO-SPONSORING
- GUARANTEED QUALITY OEM

## Revision History

Releases	Date	Notes	Prepared	Approved
Version 0.8	2015/01/30	Draft Version	James	LTu
Version 1.0	2015/05/21	Official Release Specifications	James	LTu
Version 1.1	2015/06/18	Spellings and typo corrections Updated Mechanical Drawing	James	LTu
Version 1.2	2018/01/24	Datasheet division into variants. Power consumption adjustment.	Joanna	LTu

### \* Commercial Key Legend

Indicators that assess the specific product for its position in the technology curve and the supply chain responsiveness it enjoys. They combine an inner-outer view: both from outside factors and from internal corporate and production support.

- MOI [Market Orientation Index]** A value calculated from the grading of the factors below. Used as a rule-of-thumb to aid design-in and procurement evaluation. MOI depicts the present product affinity to Innovation (I), Customer Empathy (C) and Price Focus (P).
- TECHPOINT** The position of the product within the specific technology-innovation curve for its class. VALUES: Advanced (A), Barring (B), Common (C), Dissolving (D).
- LIFESPOT** Estimated lifespan indicator. VALUES: Agonist (A), Bold (B), Current (C), Distressed (D); the earlier the letter the earlier the position in the specific product lifecycle.
- VAROD [Variants On-Demand]** An indicator of the depth and difficulties On-Demand product variations can reach and encounter. VALUES: Auxiliary (A), Basic (B), Core (C), Deep (D).
- VERTICALS** It is an index of the spread of product applications in different vertical markets. VALUES: 1 to 4; the more the target markets the higher the number, the less the product specificity to markets.
- DCO [Design Cost Orientation]** Commodity index related to the cost point for the product’s design conception. VALUES: 1 to 4; the higher the number the more cost aware is the core design.
- ELT [Effective Lead Time]** Adjusted lead-time in weeks. This is a compound value based on the timeframe for the fulfillment of the 90% of unscheduled orders received accounting also for the industrial lead-time and internal inventory buffering. VALUE: number of ELT weeks.



- SOURCING ADVISORY
- PROACTIVE SUPPLY CHAIN
- ON-DEMAND CO-SPONSORING
- GUARANTEED QUALITY OEM

<b>MILITARY GRADE 1.3GBPS THREE CHAIN, DUAL BAND 802.11AC/ABGN WLAN – INDUSTRIAL TEMPERATURE GRADE, FULL SIZE MINIPCI EXPRESS MODULE</b>	<b>1</b>
<b>REVISION HISTORY</b>	<b>2</b>
<b>* COMMERCIAL KEY LEGEND</b>	<b>2</b>
<b>DESCRIPTION</b>	<b>4</b>
<b>TOP FEATURES</b>	<b>4</b>
<b>SPECIFICATIONS</b>	<b>5</b>
<b>RATINGS / CHARACTERISTICS</b>	<b>7</b>
<b>MECHANICAL DRAWING</b>	<b>8</b>
<b>CONNECTOR PIN-OUT DEFINITIONS</b>	<b>9</b>
<b>BLOCK DIAGRAM</b>	<b>10</b>
<b>ENVIRONMENTAL PERFORMANCE QUALIFICATION</b>	<b>10</b>
<b>STANDARD DOMAIN CODE &amp; IDENTIFICATION</b>	<b>10</b>
<b>PRODUCT LABEL</b>	<b>11</b>
<b>ESD PROCESSES</b>	<b>11</b>
<b>STANDARD PACKAGING, STORAGE &amp; SHIPPING</b>	<b>11</b>
<b>ORDERING INFORMATION</b>	<b>13</b>
<b>NOTICES</b>	<b>14</b>
<b>AIRETOS™ PROFILE</b>	<b>15</b>



- SOURCING ADVISORY
- PROACTIVE SUPPLY CHAIN
- ON-DEMAND CO-SPONSORING
- GUARANTEED QUALITY OEM

## 1. Description

**11AC Dual Band (DB):** The AEX-AR99890-NI IEEE 802.11ac/abgn PCI-E WLAN is the first Military / Industrial Grade Qualcomm-Atheros Dual Band modular design compliant with the IEEE 802.11AC standard.

**New Performance Heights:** With advanced QFN, On-chip CPU for Host Wi-Fi offload, 80Mhz channel bandwidth, wider channel bandwidth (80 MHz) at 5Ghz, wider 256-QAM, 4 Gbit/s bus bandwidth, evolved QAM base band modulation technologies and 1.3 Gbps WLAN peak throughput the AEX-QCA9890-NI brings new standards to the Enterprise Market.

**Enterprise Features:** 4.9GHz frequency band support / narrow 5/10MHz channelization, Video QoS (VQoS), Dynamic Frequency Selection (DFS), Spectral Analysis, Support for Smart Antenna, Transmission Beamforming (TxBF), loopback mode for FIPS security certification, Enhanced small packet performance, Spatial Multiplexing, cyclic-delay diversity (CDD), low-density parity check (LDPC), maximum ratio combining (MRC), space time block code (STBC).

**Full Industrial Grade:** The AEX-QCA9890 is built with top quality components. Qualified under strenuous testing the NI version fully sustains operating temperatures from -40° to +85° Celsius.

## 2. Top Features



- IEEE 802.11ac Dual Band (backwards compatible with 802.11abgn)
- Industrial operating temperature grade (-40°C ~ 85°C)
- Three antenna connectors, for MIMO 3Tx3R (3 Transmit & 3 Receive) technology
- Transmission Beamforming (TxBF) with enhanced Tx power accuracy and high aggregate power
- PCI-E 2.0 standard specification with up to 4 Gbit/s bandwidth (backwards compatible to 1.x)



- SOURCING ADVISORY
- PROACTIVE SUPPLY CHAIN
- ON-DEMAND CO-SPONSORING
- GUARANTEED QUALITY OEM

### 3. Specifications

SOLUTION DESIGN	<b>Chipset</b>	Qualcomm Atheros QCA9890- BR4B
	<b>Standard</b>	IEEE 802.11 a/b/g/n/ac Wi-Fi
	<b>Industrial Reference</b>	Qualcomm Atheros reference design XB140 Enterprise Version 2
APPEARANCE	<b>Communications Interface</b>	Mini PCIE format, PCI Express Standard 2.0 host I/O
	<b>Form Factor</b>	Mini PCIE format, standard mPCIe dimensions – Full size card
ANTENNA	<b>Configuration</b>	Three Streams (3 chains), 3x3, 3 Connectors, MIMO
	<b>Type</b>	Three on board I-PEX U.FL antennas
WIRELESS PARAMETERS	<b>Frequency Band</b>	2.4 GHz ISM Bands 2.412-2.472 GHz, 2.484 GHz 4.9425-4.985 GHz (optional band support for Japan and safety markets) 5.15-5.25 GHz (FCC UNII-low band) for US/Canada, Japan and Europe 5.25-5.35 GHz (FCC UNII-middle band) for US/Canada and Europe 5.47-5.725 GHz for Europe 5.725-5.825 GHz (FCC UNII-high band) for US/Canada
	<b>Data Transfer Rates</b>	WLAN 2.4GHz: 11n: Up to 450Mbps (dynamic) 11g: Up to 54Mbps (dynamic) 11b: Up to 11Mbps (dynamic) WLAN 4.9GHz: 11n: Up to 450Mbps (dynamic) WLAN 5GHz: 11ac: Up to 1300Mbps (dynamic) 11n: Up to 450Mbps (dynamic) 11a: Up to 54Mbps (dynamic)
	<b>Media Access Control</b>	CSMA/CA with ACK
	<b>Channel</b>	2.4GHz: 1-13 (14 only for Japan) 4.9GHz: 7x20MHz (20-80), 2x10MHz (10, 90), 10x5MHz (5-95) 5GHz: 36-48, 149-165
	<b>Channel Spacing</b>	5MHz, 10MHz and 20 MHz selectable
	<b>Spreading / Modulation</b>	802.11ac/g/n: OFDM (BPSK,QPSK,16-QAM,64-QAM), MRC, STBC, LDPC, ML Demodulation 802.11b: CCK (11, 5.5Mbps), DQPSK (2Mbps), BPSK (1Mbps)



- SOURCING ADVISORY
- PROACTIVE SUPPLY CHAIN
- ON-DEMAND CO-SPONSORING
- GUARANTEED QUALITY OEM

	<b>RF Output Power</b>	<p>802.11a: Typical 13 dBm at 54M / 16dBm at 6M +- 2dBm                  802.11b: Typical 18dBm +/- 2 dBm                  802.11g: Typical 13 dBm at 54M / 18dBm at 6M +- 2dBm                  802.11n 5G HT20 : Typical 21 dBm at MCS0 / 16dBm at MCS7 +/- 2dBm                  802.11n 5G HT40 : Typical 21 dBm at MCS0 / 16dBm at MCS7 +/- 2dBm                  802.11n 2.4G HT20 : Typical 22 dBm at MCS0 / 16dBm at MCS7 +/- 2dBm                  802.11n 2.4G HT40 : Typical 22 dBm at MCS0 / 16dBm at MCS7 +/- 2dBm                  802.11ac 5G VHT20 : Typical 21 dBm at MCS0 / 15dBm at MCS8 +/- 2dBm                  802.11ac 5G VHT40 : Typical 21 dBm at MCS0 / 15dBm at MCS8 +/- 2dBm                  802.11ac 5G VHT80 : Typical 21 dBm at MCS0 / 14dBm at MCS8 +/- 2dBm</p> <ul style="list-style-type: none"> <li>• DBm values reflect single RF chain output power performance.</li> <li>• Three chain combined output power can be calculated as the single chain output power above plus 5dB (3Tx = 1Tx + 5dB).</li> </ul>
	<b>RF Receive Sensitivity (Typical)</b>	<p>802.11a: 54M less than -70 dBm                  802.11b: 11M less than -85 dBm                  802.11g: 54M less than -70 dBm                  802.11n 2.4G: HT20 MCS7 less than -72 dBm                                    HT40 MCS7 less than -69 dBm                  802.11a 4.9GHz: 54M less than -75 dBm                                    6M less than -85 dBm                  802.11n 5G: HT20 MCS7 less than -72 dBm                                    HT40 MCS7 less than -69 dBm                  802.11ac 5G: VHT20 MCS8 less than -68 dBm                                    VHT40 MCS8 less than -64 dBm                                    VHT40 MCS8 less than -61 dBm</p>
	<b>Operating Range</b>	<p>Open Space: ~300 m; Indoor: ~100 m                  (Coverage vary according to environment, antenna and topography)</p>
	<b>Wireless Security</b>	<p>WEP 64-bit and 128-bit encryption                  WPA (Wi-Fi Protected Access)                  WPA2 (Wi-Fi Protected Access)</p>
<b>WORKING MODES</b>	<p>Infrastructure, Client, Bridge, Ad-hoc</p>	
<b>SAFETY, EMISSION &amp; REGULATORY</b>	<p>Compliant with FCC, CE and IC.                  Compliant with RoHS.</p>	
<b>PROTOCOLS</b>	<b>IEEE WLAN Network</b>	<p>802.11ac, 802.11n , 802.11g, 802.11b, 802.11a, 802.11d, 802.11e, 802.11h, 802.11j and 802.11i</p>
	<b>Other Standards</b>	
	<b>Industry Standards</b>	
<b>HOST SYSTEM REQUIREMENTS</b>	<b>Operating System</b>	<p>Linux, Linux Open Source, Qualcomm-Atheros Embedded Platform                  (Windows on request)</p>
<b>ENVIRONMENT</b>	<b>Operating Temperature</b>	<p>-40° ~ +85° Celsius</p>



- SOURCING ADVISORY
- PROACTIVE SUPPLY CHAIN
- ON-DEMAND CO-SPONSORING
- GUARANTEED QUALITY OEM

	<b>Storage Temperature</b>	-40° ~ +90° Celsius	
	<b>Operating Humidity</b>	10%~90% non-condensing	
	<b>Storage Humidity</b>	5%~90% non-condensing	
ELECTRICAL	<b>I/O Voltage</b>	3.3V +/-5%	
	<b>Power Consumption</b>	Transmit Packet Test HT 40*:	1151.27 mA max
		Receiver Packet Test HT 40*:	563.64 mA max
MECHANICAL	<b>Dimensions</b>	50.95mm x 30mm x 3.15mm (with shielding)	
	<b>Weight</b>	6.1 g	
PACKAGING	<b>Packing style</b>	ESD Sleeves in Carton Bulk Package	
	<b>Package Contents</b>	AEX-QCA9890-NI IEEE 802.11 ac/abgn mPCI-E modules	

## 4. Ratings / Characteristics

### 4-1. Absolute Maximum Ratings

Symbol	Parameter	Max. Rating	Unit
V <sub>dd33</sub>	Maximum I/O supply voltage	3.63	V
R <sub>Fin</sub>	Maximum RF input (reference to 50 Ω)	+10	dBm
T <sub>store</sub>	Storage temperature	-40~+90	°C

### 4-2. Recommended Operating Conditions

Symbol	Parameter	Rating	Unit
V <sub>dd33</sub>	I/O voltage	2.97~3.63	V

### 4-3. GPIO Interface Characteristics

Signal Name (To chip GPIO PIN)	Mini PCI-E PIN	Type	Driver	PU/DPResistance
WLAN_LED	44	O	24 mA (Max)	None-PU
WLAN_DISABLE	20	I	_	100 KΩ PU



- SOURCING ADVISORY
- PROACTIVE SUPPLY CHAIN
- ON-DEMAND CO-SPONSORING
- GUARANTEED QUALITY OEM

## 5. Mechanical Drawing

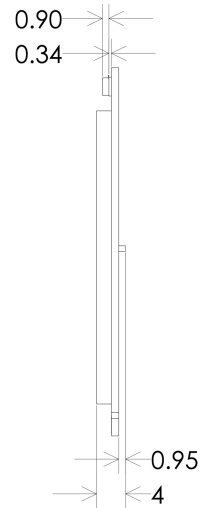
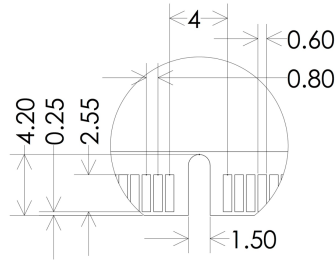
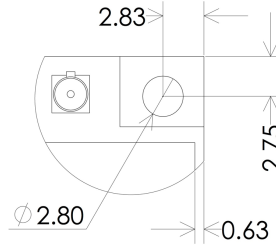
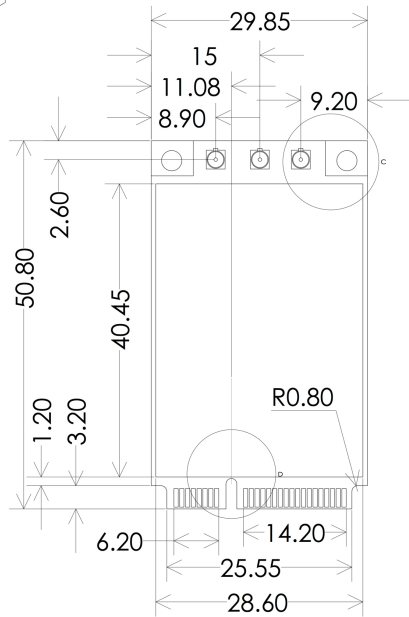
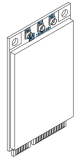



- SOURCING ADVISORY
- PROACTIVE SUPPLY CHAIN
- ON-DEMAND CO-SPONSORING
- GUARANTEED QUALITY OEM

## 6. Connector Pin-out Definitions

Pin #	Definition	Basic Description	Type
1	PCIE_WAKE_L	PCIe Wake	YES
2	3.3V aux	3.3V power supply	YES
4	GND	Ground	GND
7	CLKREQ_L	Reference clock request, open drain	YES
8	MCI_CLK_IN	Open, by Design request	NC
9	GND	Ground	GND
10	MCI_CLK_OUT	Open, by Design request	NC
11	REFCLK-	Differential reference clock	YES
12	UIM_CLK	Open, by Design request	NC
13	REFCLK+	Differential reference clock	YES
14	MCI_DATA_IN	Open, by Design request	NC
15	GND	Ground	GND
18	GND	Ground	GND
20	W_DISABLE_L	WLAN disable control. Low disables WLAN. Module P.U	YES (GPIO_0)
21	GND	Ground	GND
22	PERST_L	PCI express fundamental reset	YES
23	PCIE_TX_N	Differential transmit	YES
24	+3.3Vaux	3.3V power supply	YES
25	PCIE_TX_P	Differential transmit	YES
26	GND	Ground	GND
27	GND	Ground	GND
29	GND	Ground	GND
31	PCIE_RX_N	Differential receive	YES
33	PCIE_RX_P	Differential receive	YES
34	GND	Ground	GND
35	GND	Ground	GND
37	GND	Designed	GND
39	+3.3Vaux	Place R31 (0 Ohm) if PCIe 1.1 power supply compatibility	NC
40	GND	Ground	GND
41	+3.3Vaux	Place R31 (0 Ohm) if PCIe 1.1 power supply compatibility	NC
43	GND	Ground	GND
44	LED_WLAN_L	Active low signal. The signal is used to provide WLAN LED indicate	YES(GPIO_1)
46	LED_WPAN_L	Active low signal. The signal is used to provide BT LED indicate	YES(GPIO_17)
50	GND	Ground	GND
52	+3.3V	3.3V power supply	YES

Interface Format	Bus Signaling	Standard
MiniPCI Express	PCI Express	PCI-SIG v2.0

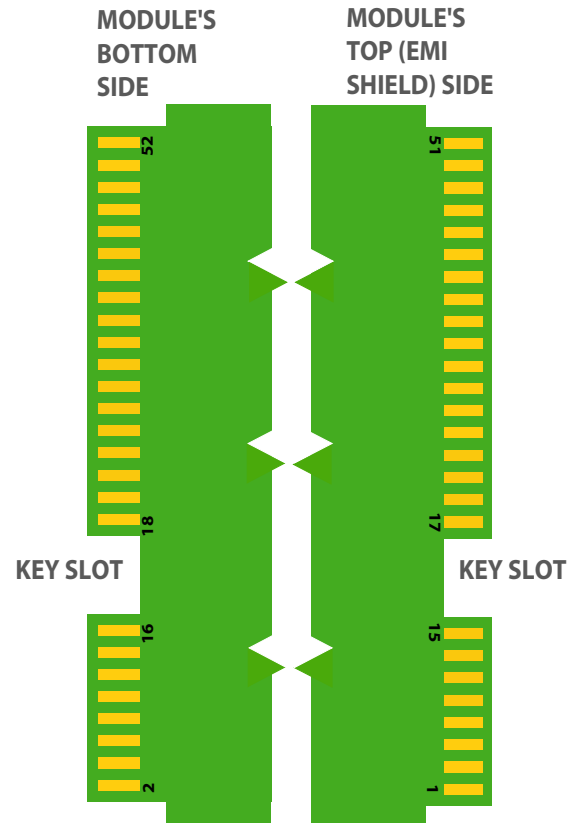

\*Pin/Contact Numbers not appearing in the above table are either reserved or unused.



- SOURCING ADVISORY
- PROACTIVE SUPPLY CHAIN
- ON-DEMAND CO-SPONSORING
- GUARANTEED QUALITY OEM

## 7. Block Diagram

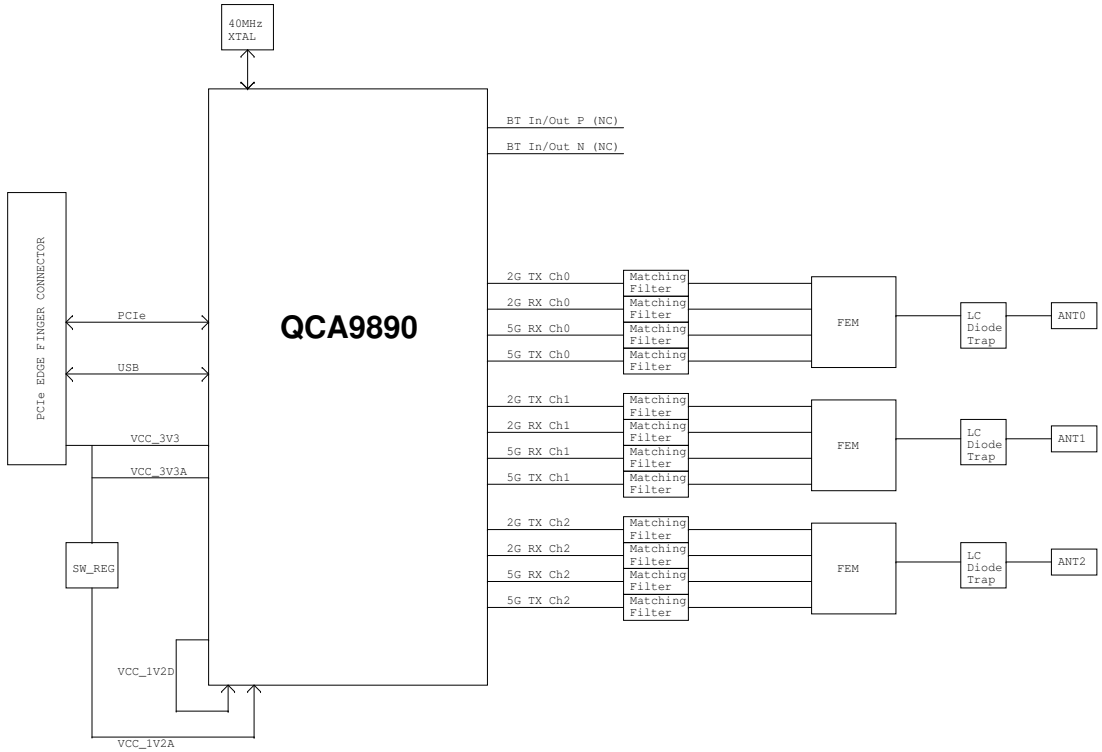

## 8. Environmental Performance Qualification

Throughput test at controlled thermal conditions with 70dB attenuation: PENDING

## 9. Standard Domain Code & Identification

The Regulatory Domain pre-programmed as standard is 0x6A [wide open world mode].

Other regulatory domain codes can be pre-programmed on-request at production batch level.

Implemented as standard are identifiers following Qualcomm Atheros XB140 reference design:



- SOURCING ADVISORY
- PROACTIVE SUPPLY CHAIN
- ON-DEMAND CO-SPONSORING
- GUARANTEED QUALITY OEM

	Vendor ID (VID)	Subsystem Vendor ID (SVID)	Device ID (DID)	Subsystem ID (SSID)
STANDARD WLAN	0x168C	0x168C	0x00	0x31

## 10. Product Label

### 10-1. Front (Shield) Side Regulatory Label

Standard label is shown here. It includes the required marking for the following regulatory areas: FCC (USA), ETSI (Europe), EU Safety & Environmental.

Wireless LAN NIC MAC ID label (human legible and barcode).

Serial Number label (human legible and barcode) plus Variant Number.

### 10-3. On-Demand Labeling

Labels can be tailored to report customer’s part number and regulatory compliance following VoxMicro’s and Qualcomm Atheros XB140 Enterprise Version 2 reference design certifications for any of the countries and domains required.

## 11. ESD Processes

See Notices appended.

## 12. Standard Packaging, Storage & Shipping

ESD Sleeve, Inner Box & Outer Carton level standard packing schematic \* :



- SOURCING ADVISORY
- PROACTIVE SUPPLY CHAIN
- ON-DEMAND CO-SPONSORING
- GUARANTEED QUALITY OEM



	Module in ESD Sleeve	Inner Box Kit (K)	Master Carton (M)
CONTENT (UNITS)	1	60	960
INVENTORY SKU	AEX-QCA9890-NI	AEX-QCA9890-NI -K	AEX-QCA9890-NI -M
OUTER DIMENSIONS	70 x 60 x 3.5 mm	204 x 165 x 65 mm	430 x 350 x 285 mm
GROSS WEIGHT	6.2 gr	430 gr	8000 gr
PICK & PACK METHOD	Padded envelope or carton box depending on quantity. Padded & separated.	In outer carton packaging.	As-is.
PACKAGING COMPLIANCE **	ANSI/ESD S20.20, IEC 61340-5-1, RoHS2	RoHS2	RoHS2
HTS CODE (HS)	8517.62	8517.62	8517.62
NAFTA / ECCN	On request	On request	On request

\* Packaging modality and artwork can be designed as per customer’s requirements.

\*\* The Packaging modality and the selection of its materials is made with environmental responsibility and commitment to resource preservation. Please reuse and recycle where possible.

The AEX-QCA9890-NI constitutes a sensitive electronic device and caution is required when handling it. ESD handling, shipment and storage notices apply:



**DO NOT OPEN OR HANDLE EXCEPT AT A STATIC-FREE WORKSTATION**

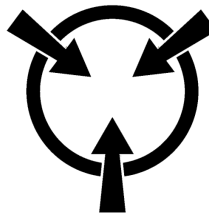

**DO NOT SHIP OR STORE NEAR STRONG ELECTROSTATIC, ELECTROMAGNETIC OR RADIOACTIVE FIELDS**



- SOURCING ADVISORY
- PROACTIVE SUPPLY CHAIN
- ON-DEMAND CO-SPONSORING
- GUARANTEED QUALITY OEM

## 13. Ordering Information

Public variants, their differential characteristics and ordering information:

	Ordering P/N	Variant IDs	Description
<b>Full Industrial VARIANT</b>	AEX-QCA9890-NI	1 / 04	- QCA9890-BR4B Chipset - Standard product - Standard packaging



- SOURCING ADVISORY
- PROACTIVE SUPPLY CHAIN
- ON-DEMAND CO-SPONSORING
- GUARANTEED QUALITY OEM

## 14. NOTICES

**STORAGE:** The product shall be stored without opening the packing according to storage environmental conditions noted within this datasheet. - The product shall be stored in non corrosive gas (Cl<sub>2</sub>, NH<sub>3</sub>, SO<sub>2</sub>, Nox, etc.). - Any excess mechanical shock including, but not limited to, sticking the packing materials by sharp object and dropping the product, shall not be applied in order not to damage the packing materials.

**SHELVE LIFE:** Product left more than two years after reception needs to be confirmed to its specifications before use.

**HANDLING:** Be careful in handling or transporting products because excessive stress or mechanical shock may break products. - Handle with care if products may have cracks or damages on their terminals, the characteristics of products may change. Do not touch products with bare hands as such may result in electrostatic damage. - Since the application of static electricity or overvoltage may cause defect in the product or deterioration of its reliability, caution must be taken against exposure to any static electricity generated by electrified items such as workbenches, soldering irons, tools, carrying containers, etc.

**LAND PATTERN & DIMENSIONS:** All the ground terminals should be connected to the ground patterns. Furthermore, the ground pattern should be provided between IN and OUT terminals. Please refer to the specifications for the standard land dimensions.

**MECHANICAL PLACEMENT:** When mounting products connected to other components, products may be stressed and broken by uneven forces. To prevent products from damages, be sure to follow the specifications for the tools and interfaces being used.

**CLEANING:** Since this Product is Moisture Sensitive, any cleaning is not permitted.

**OPERATIONAL ENVIRONMENTAL CONDITIONS:** Products are designed to work for electronic products under normal environmental conditions (ambient temperature, humidity and pressure). If products are used under the following circumstances, it may damage products and leakage of electricity and abnormal temperature may occur:

- In an atmosphere containing corrosive gasses (Cl<sub>2</sub>, NH<sub>3</sub>, SO<sub>x</sub>, NO<sub>x</sub>) or combustible and volatile gases - Dusty place - Direct sunlight place - Water splashing place - Humid place where water condenses - Freezing place - etc.

If there are possibilities for products to be used under the preceding clause, consult with AIRETOS before actual use. As it might be a cause of degradation or destruction to apply static electricity to products, do not apply static electricity or excessive voltage while assembling and measuring.

**INPUT POWER CAPACITY:** Products shall be used in the input power capacity as specified in this specification. Discuss with AIRETOS beforehand, in need that the components are used beyond such input power capacity range.

**LIMITATION OF APPLICATIONS:** The product is designed and manufactured for consumer application only and is not available for any application listed below which requires especially high reliability for the prevention of such defect as may directly cause damage to the third party's life, body or property.

- Aircraft equipment - Aerospace equipment - Undersea equipment - Power plant control equipment - Medical equipment - Transportation equipment (vehicles, trains, ships, etc.) - Traffic signal equipment - Disaster prevention / crime prevention equipment - Data-processing equipment - Application of similar complexity and/ or reliability requirements to the applications listed in the above.

In case the product is to be used in equipment or electric circuit that requires high safety or reliability function or performances, sufficient reliability evaluation check for safety shall be performed before commercial shipment and moreover, due consideration to install a protective circuit is strongly recommended at customer's design stage. Please provide and appropriate fail-safe function on your product to prevent any damages that may be caused by the abnormal function or the failure of our product.

**QUALITY CONTROL:** Testing and other quality control techniques are used to the extent AIRETOS deems necessary. Unless mandated by government requirements, AIRETOS does not necessarily test all parameters of each product.

**LIFECYCLE:** Please note that we may discontinue the manufacture of products, due to reasons such as end of supply of materials and/or components from our suppliers.

**CONFORMITY:** Please make sure that your product has been evaluated and confirmed against your specifications when our product is mounted to your product. Please conduct validation and verification of the products in actual condition of mounting and operating environment before commercial shipment of the equipment. All the items and parameters in this product specification have been prescribed on the premise that our product is used for the purpose, under the condition and in the environment agreed upon between you and us. You are requested not to use our product deviating from such agreement. We consider it not appropriate to include other terms and conditions for transaction warranty in product specifications, drawings or other technical documents. Therefore, even if your original part of this product specification includes such terms and conditions as warranty clause, product liability clause, or intellectual property infringement liability clause, we are not able to accept such terms and conditions in this product specification unless they are based on the governmental regulation or what we have agreed otherwise in a separate contact. We would like to suggest that you propose to discuss them under negotiation of contract.

**DISCLAIMER:** Please note that the only warranty that AIRETOS (DBA part of the VoxMicro LTD Group) provides regarding the products is its conformance to the specifications provided herein. Accordingly, AIRETOS shall not be responsible for any defects in products or equipment incorporating such products, which are caused under the conditions other than those specified in this specification.

AIRETOS HEREBY DISCLAIMS ALL OTHER WARRANTIES REGARDING THE PRODUCTS, EXPRESS OR IMPLIED, INCLUDING WITHOUT LIMITATION ANY WARRANTY OF FITNESS FOR A PARTICULAR PURPOSE, THAT THEY ARE DEFECT-FREE, OR AGAINST INFRINGEMENT OF INTELLECTUAL PROPERTY RIGHTS. YOU AGREE TO INDEMNIFY AND DEFEND AIRETOS AND ITS AFFILIATES AGAINST ALL CLAIMS, DAMAGES, COSTS, AND EXPENSES THAT MAY BE INCURRED, INCLUDING WITHOUT LIMITATION, ATTORNEY FEES AND COSTS, DUE TO THE USE OF PRODUCTS.

AIRETOS's liability under this warranty shall be limited to products that are returned during the warranty period to the address designated by AIRETOS and that are determined by AIRETOS not to conform to such warranty. If AIRETOS elects to repair or replace such products, AIRETOS shall have reasonable time to repair such products or provide replacements. Repaired products shall be warranted for the remainder of the original warranty period. Replaced products shall be warranted for a new full warranty period.

For avoidance of doubt, AIRETOS shall not be liable for any defects that are caused by neglect, misuse or mistreatment by an entity other than AIRETOS including improper installation or testing, or for any products that have been altered or modified in any way by an entity other than AIRETOS. Moreover, AIRETOS shall not be liable for any defects that result from your or third party's design, specifications or instructions for such products.



- SOURCING ADVISORY
- PROACTIVE SUPPLY CHAIN
- ON-DEMAND CO-SPONSORING
- GUARANTEED QUALITY OEM

## AIRETOS™ PROFILE

5 Locations – 80% Direct Market Coverage – Affiliate Support



### Quality Functions at all Stages



### Behind the Scenes

- 5%** OF REVENUE • INVESTED IN INNOVATION R&D
- 10 YEARS** HANDS-ON IN • OEM/ODM WIRELESS
- DECADES OF** • CUMMILATIVE ENGINEERING
- HUNDREDS OF** • ROUTINE INDUSTRIAL
- THOUSANDS OF** • TUNING HOURS YEARLY
- MILLIONS OF** • INTERNAL AND EXTERNAL

### World Distribution & Samples via OxfordTEC®

- FREE SHIPPING** \*on orders above \$100
- CARD, CHECK OR P.O.** NET Terms for trade & government
- 30-DAY RETURNS** peace of mind on all items
- WORLD SHIPPING** \*also via your courier for account customers

FOR FURTHER INFORMATION, DEVELOPMENT SAMPLES, CUSTOMIZATION AND VOLUME PRICING CONTACT US VIA [AIRETOS.COM](http://AIRETOS.COM) OR VIA THE VOXMICRO GROUP WHOLESALERS - FOR CONTACTS SEE [WWW.VOXMICRO.TEL](http://WWW.VOXMICRO.TEL)

